

**SIEMENS**

**BenQ***mobile*

**BenQ***mobile*

**SIEMENS**

Issued by  
BenQ Mobile GmbH & Co. OHG  
Haidenauplatz 1  
D-81667 Munich

© BenQ Mobile GmbH & Co. OHG 2005  
All rights reserved. Subject to availability.  
Rights of modification reserved.  
Manufactured by BenQ Mobile GmbH & Co. OHG  
under trademark license of Siemens AG

[www.siemens.com/sfg75](http://www.siemens.com/sfg75)



Designed for life

**SFG75**

# Safety Information

**For your safety, please read the guidelines below carefully before you use your phone:**

## **Exposure to Radio Frequency Signals**

Your wireless handheld portable telephone is a low power transmitter and receiver. When it is ON, it receives and also sends out radio frequency (RF) signals.

European and international agencies have set standards and recommendations for the protection of public exposure to RF electromagnetic energy.

- International Commission on Non-Ionizing Radiation Protection (ICNIRP) 1996
- Verband Deutscher Elektroingenieure (VDE) DIN- 0848
- Directives of the European Community, Directorate General V in Matters of Radio Frequency Electromagnetic Energy
- National Radiological Protection Board of the United Kingdom, GS 11, 1988
- American National Standards Institute (ANSI) IEEE. C95.1- 1992
- National Council on Radiation Protection and Measurements (NCRP). Report 86
- Department of Health and Welfare Canada. Safety Code 6

These standards are based on extensive scientific review. For example, over 120 scientists, engineers and physicians from universities, government health agencies and industry reviewed the available body of research to develop the updated ANSI Standard.

The design of your phone complies with these standards when used normally.

## **Specific Operating Restrictions**

No metallic component allowed in body-worn accessories.

### **Antenna Care**

Use only the supplied or approved replacement antenna. Unauthorized antennas, modifications or attachments may damage the phone and violate GCF regulations.

### **Phone Operation**

- Normal Position: Hold the phone as you would with any other telephone.
- To avoid potential RF interference, please do not wear the phone around your neck or in front your chest for long hours.

### **Batteries**

- For safety concerns, when the temperature of the phone goes over 45°C (113°F) or below 0°C (32°F), charging will halt.
- Do not expose batteries to temperatures below 0°C (32°F) or above 45°C (113°F). Always take your phone with you when you leave your vehicle.
- Use only genuine Benq battery to ensure the phone's normal operation.

All batteries can cause property damage, injury or burns if a conductive material such as jewelry, keys or beaded chains touches exposed terminals. The material may complete electrical circuit and become quite hot. To protect against such unwanted current drain, exercise care in handling any charged battery, particularly when placing it inside your pocket, purse or other container with metal objects. When battery is detached from the phone, your batteries are packed with a protective battery cover; please use this cover for storing your batteries when not in use.

## **Driving**

Check the laws and regulations on the use of wireless telephones in the areas where you drive. Always obey them. Also, if using your phone while driving, please:

- Give full attention to driving--driving safety is your first responsibility.
- Use hands-free operation, if available.
- Pull off the road and park before making or answering a call if driving conditions so require.

## **Electronic Devices**

Most modern electronic equipment is shielded from RF signals. However, certain electronic equipment may not be shielded against the RF signals from your wireless phone.

## **Pacemakers**

The Health Industry Manufacturers Association recommends that a minimum separation of 20 cm/9 inches be maintained between a handheld wireless phone and a pacemaker to avoid potential interference with the pacemaker. These recommendations are consistent with the independent research by and recommendations of Wireless Technology Research.

Persons with pacemakers:

- Should **ALWAYS** keep the phone more than six inches from their pacemaker when the phone is turned **ON**.
- Should not carry the phone in a breast pocket.
- Should use the ear opposite the pacemaker to minimize the potential for interference.

If you have any reason to suspect that the interference is taking place, turn your phone **OFF** immediately.

## **Hearing Aids**

Some digital wireless phones may interfere with some hearing aids. In the event of such interference you may want to consult your hearing aid manufacturer to discuss alternatives.

## **Other Medical Devices**

If you use any other personal medical device, consult the manufacturer of your device to determine if they are adequately shielded from external RF energy. Your physician may be able to assist you in obtaining this information.

Turn your phone **OFF** in health care facilities when any regulations posted in these areas instruct you to do so. Hospitals or health care facilities may be using equipment that could be sensitive to external RF energy.

## **Vehicles**

RF signals may affect improperly installed or inadequately shielded electronic systems in motor vehicles. Check with the manufacturer or its representative regarding your vehicle. You should also consult the manufacturer of any equipment that has been added to your vehicle.

## **Posted Facilities**

Turn your phone **OFF** in any facility where posted notice so requires.

## **Aircraft**

FCC regulations prohibit using your phone while in the air. Switch **OFF** your phone before boarding an aircraft.

## **Blasting Areas**

To avoid interfering with blasting operations, turn your phone **OFF** when in a "blasting area" or in area posted "TURN OFF TWO-WAY RADIO." Obey all signs and instructions.

## **Potentially Explosive Atmospheres**

Turn your phone **OFF** and do not remove the battery when in any area with a potentially explosive atmosphere and obey all signs and instructions. Sparks, from your battery, in such areas could cause an explosion or fire resulting in bodily injury or even death.

Areas with a potentially explosive atmosphere are often, but not always clearly marked. They include fueling areas such as gasoline stations; below deck on boats; fuel or chemical transfer or storage facilities; vehicles using liquefied petroleum gas (such as propane or butane); areas where the air contains chemicals or particles, such as grain, dust, or metal powders; and any other area where you would normally be advised to turn off your vehicle engine.

## **For Vehicles Equipped with an Air Bag**

An air bag inflates with great force. **DO NOT** place objects, including both installed or portable wireless equipment, in the area over the air bag or in the air bag deployment area. If in-vehicle wireless equipment is improperly installed and the air bag inflates, serious injury could result.

## European Union Directives Conformance Statement

This device complies with the OJ-Directive as below:

Electromagnetic Compatibility Directive (89/336/EEC), Low Voltage Directive (73/23/EEC)

And R&TTE Directive (99/05/EEC).

And also complies with the standard: **CE 0168**

The declaration of conformity (DoC) concerned has been signed. Please call the company hotline if you require a copy of the original or: [www.siemens.com/mobiledocs](http://www.siemens.com/mobiledocs)

**3GPP TS 51.010-1**

**EN 301 511**

**EN 50360/ EN 50361**

**ETSI EN 301 489-1/-7**

**EN 60950**





**ETSI EN 301 908-1 & ETSI EN 301 908-2**

**& ETSI EN 301 489-24 (WCDMA)**





**ETSI EN 300 328 & ETSI EN 301 489-17 (Bluetooth)**

## Safety precautions

	<p style="text-align: center;"><b>Information for parents</b></p> <p>Please read the operating instructions and safety precautions carefully before use.</p> <p>Explain the content and the hazards associated with using the phone to your children.</p>
---	---

	<p>Remember to comply with legal requirements and local restrictions when using the phone. For example in aeroplanes, petrol stations, hospitals or while driving.</p>
	<p>Mobile phones can interfere with the functioning of medical devices such as hearing aids or pacemakers. Keep at least 20 cm/9 inches between phone and pacemaker. When using the mobile phone hold it to the ear which is further away from the pacemaker. For more information consult your doctor.</p>
	<p>Small parts such as the SIM card, sealing stop, lens ring and lens cap can be dismantled and swallowed by small children. The phone must therefore be stored out of the reach of small children.</p>
	<p>Do not place the phone near to electromagnetic data carriers such as credit cards and floppy disks. Information stored on them could be lost.</p>
	<p>Do not look at the LED (e.g. activated infrared port, flash LED) with optical magnifiers because of radiation.</p> <p>This product complies with IEC/EN 60825-1 "Safety of Laser Products" for LED Class 1M products; such products are safe under reasonably foreseeable operating conditions.</p>



	<p>The mains voltage specified on the power supply unit (V) must not be exceeded. Otherwise the charging device may be destroyed.</p> <p>The power supply must be plugged into an easily accessible AC mains power socket when charging the battery. The only way to turn off the charging device after charging the battery is to unplug it.</p>
	<p>The ringtones, info tones and handsfree talking are reproduced through the loudspeaker. Do not hold the phone to your ear when it rings or when you have switched on the handsfree function. Otherwise you risk serious permanent damage to your hearing.</p>
	<p>Only use original batteries (100 % mercury-free) and – charging devices. Otherwise you risk serious damage to health and property. The battery could explode, for instance.</p>
	<p>You may only open the phone to replace the battery (100 % mercury-free) or SIM card. You must not open the battery under any circumstances. All other changes to this device are strictly prohibited and will invalidate the guarantee.</p>
	<p>All electrical and electronic products should be disposed of separately from the municipal waste stream via designated collection facilities appointed by the government or the local authorities.</p> <p>This crossed-out wheeled bin symbol on the product means the product is covered by the European Directive 2002/96/EC.</p> <p>The correct disposal and separate collection of your old appliance will help prevent potential negative consequences for the environment and human health. It is a precondition for reuse and recycling of used electrical and electronic equipment.</p> <p>For more detailed information about disposal of your old appliance, please contact your city office, waste disposal service or the shop where you purchased the product.</p>



The phone may cause interference in the vicinity of TV sets, radios and PCs.



As mobile devices offer a range of functions, they can be used in positions other than the head, such as on the body. In this case, at data transfer (GPRS) a separation distance of **1.5 cm** is required.

## Bluetooth<sup>®</sup>

Your phone has a Bluetooth interface. This makes it possible to establish a wireless connection of your phone with a headset of a car kit, or with other Bluetooth-enabled devices.

In order to establish a secure link between the devices and to prevent a third party from having access to your phone, you should observe the following points:

- The initial connection between two devices, what is called "pairing", should take place in familiar surroundings.
- Both devices must be able to identify themselves one time by using a password/PIN. To ensure sufficient security, you should choose a 16-digit number combination for a password that would be difficult to guess (if a PIN has not been assigned).
- An automatic connection acceptance ("connection without confirmation") should only be used in exceptional cases.
- In general, only trustworthy devices should be linked in order to minimize security risks.
- You should restrict the "visibility" of your phone if possible. This will make it much more difficult for unknown devices to establish a connection with your phone.

- The name of your phone is transmitted in a Bluetooth connection. The factory default is the "Bluetooth ID". The first time Bluetooth is activated, or later in the Bluetooth menu, you can change this name.
- If Bluetooth is not needed, this function should be deactivated.

Before using Bluetooth accessories, or a mobile phone inside a vehicle, check the vehicle user guide for any limitations on the use of these products.



To ensure perfect operation of the phone, please only use the phone with the keypad completely open or completely closed.

---

# Table of Contents

<b>Safety Information</b> .....	<b>i</b>
<b>Safety precautions</b> .....	<b>vii</b>
Bluetooth®.....	ix
<b>1. Preparing Your Phone For Use</b> .....	<b>1</b>
Inserting a SIM Card .....	1
Installing the Battery.....	3
Charging the Phone .....	4
Turning the Phone On .....	5
The miniSD Card.....	6
<b>2. Getting to Know Your Phone</b> .....	<b>7</b>
Your Phone at a Glance .....	7
Sub Display.....	10
Idle Screen .....	10
Using the Keys in Idle Mode .....	13
Menu Navigation .....	15
<b>3. Using Your Phone</b> .....	<b>16</b>
Call Functions .....	16
Making a Phone Call.....	16
Ending a Phone Call.....	16
Answering a Phone Call.....	16
Rejecting an Incoming Call.....	16
Adjusting the Volume .....	17
Making an International Call .....	17
Making an Emergency Call.....	17

Dialing an Extension Number .....	17
Listening to Voicemails .....	18
Operations During a Call .....	18
Making a Video Call .....	22
Answering a Video Call .....	23
Video Call Settings .....	23
Options During a Video Call .....	24
Phone Book .....	26
Adding Contacts to the Phone Book .....	26
Finding Contacts in the Phone Book .....	28
Last Missed, Dialed, and Received Calls .....	28
Using the Silent Profile .....	29
Camera .....	30
Taking Pictures .....	30
Camera Settings .....	31
More Camera Settings .....	31
Managing Your Pictures .....	32
Camcorder .....	33
Shooting a Video Clip .....	33
Camcorder Settings .....	34
More Camcorder Settings .....	34
Managing Your Videos .....	35
MP3 Player .....	35
Building a play list .....	35
Playing the music .....	36
Uploading music to your phone .....	36

Messages .....	37
SMS .....	37
MMS.....	40
E-Mail .....	43
Voicemail.....	44
Broadcast.....	45
Input Modes.....	46
Letter Input Mode (Abc) .....	46
Predictive Input Mode (iTap) .....	47
Numeric Input Mode (123).....	48
Symbol Input Mode .....	48
Using the Bluetooth.....	48
Establishing Connection with Your Bluetooth Headset .....	48
Organizing your Devices.....	49
PC Synchronization and Data Transfer.....	50
<b>4. Menus.....</b>	<b>51</b>
Phone Book.....	51
List.....	51
Find .....	51
Add.....	51
Copy.....	52
Delete .....	52
Caller Group.....	52
Own Number.....	52
Memory.....	52
Messages .....	53

Calls .....	53
Missed .....	53
Received .....	53
Dialed .....	53
Cleanup All .....	53
Display .....	54
Duration and Cost.....	54
Games .....	54
Settings .....	55
Entertainment .....	55
Camera .....	55
Camcorder .....	55
MP3 Player.....	55
Media Center.....	56
Images .....	56
Videos.....	57
Music.....	58
Others.....	58
Tools .....	59
Alarm .....	59
Clock Options.....	60
Calendar.....	60
Calculator.....	61
Currency Converter .....	61
Stopwatch .....	62
Countdown Timer.....	62
Connections.....	62

Services .....	63
WAP Browser .....	63
WAP Messages.....	64
WAP Settings.....	64
STK.....	64
Settings .....	65
Date & Time .....	65
Profiles .....	65
Display .....	67
Call Settings .....	68
Network .....	72
Security .....	73
Power Saving .....	74
Language .....	74
Power On/Off Sound .....	74
Memory.....	74
Restore .....	74
<b>5. Care and Maintenance .....</b>	<b>75</b>
Battery quality statement.....	76
Display quality declaration.....	76
<b>6. Troubleshooting.....</b>	<b>77</b>
<b>7. Customer Care .....</b>	<b>81</b>
<b>8. SAR.....</b>	<b>85</b>
European Union (RTTE) and international (ICNIRP) .....	85



<b>9. Guarantee certificate (UK) .....</b>	<b>87</b>
<b>10. Guarantee certificate (IRL).....</b>	<b>89</b>
<b>11. End User License Agreement (EULA) .....</b>	<b>92</b>

# 1 Preparing Your Phone For Use

## Inserting a SIM Card

 Please note:

- In this user manual, "SIM card" implies either a SIM or an USIM card, unless it is specifically specified as "USIM card".
  - To use your mobile phone in the UMTS network, you will need to have a USIM card. See page 72, "3G/GSM Networks" to find out more about selecting the correct network mode for use.
1. Turn the phone over, and release the battery latch. Lift the battery off the phone.

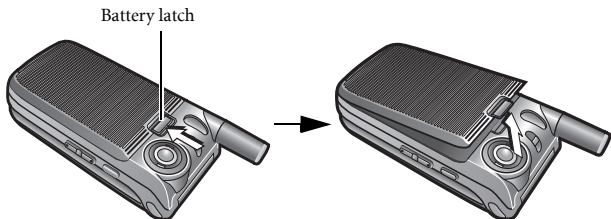

Do not remove the battery when the phone is on. Doing so could cause you to lose personal settings or data stored either on your SIM card or in the phone's memory.

- Slide the SIM card into the SIM card slot, with the SIM card's metal contacts facing downwards and the cut corner at the bottom left.

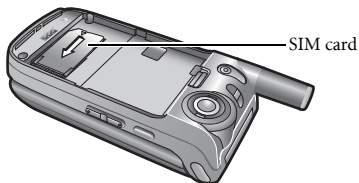

A SIM card can be easily damaged if its metal contacts become scratched. Therefore, take special care when holding or inserting it.



To remove the SIM card, you must first press down the stay, then push the SIM card out of the slot.

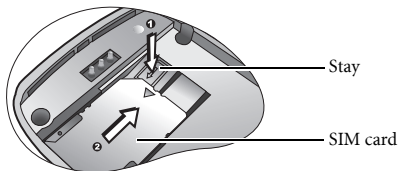

## Installing the Battery

With the battery's metal contacts facing downwards, align the protruding tabs on the end with the holes in the battery bay. Then push the battery toward the end of the bay to insert the battery's tabs into the holes. Press down to click the battery into place.

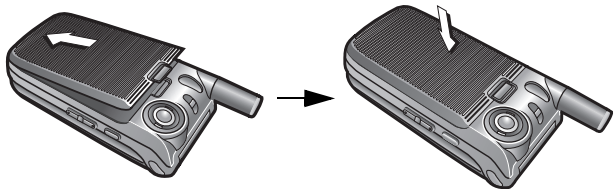

Do not remove the battery when the phone is on. Doing so could cause you to lose personal settings or data stored either on your SIM card or in the phone's memory.

## Charging the Phone

1. Insert the charger connector deep into the charger socket at the bottom of your phone. Ensure that the connector is plugged in the right direction with the side showing arrow icon or "up" facing upwards.



2. Plug the charger into a power outlet.



Do not remove the battery while the phone is charging.



3. Once the phone is fully charged, remove the charger from both the power outlet and the phone.



Please note:

- It takes approximately 4 hours to fully charge a battery.
- When the battery is weak, the phone will play an alert sound.
- When the battery is discharged, the charging may not start immediately when you plug in the connector. Wait 10 to 15 minutes for the phone to begin charging.



# Turning the Phone On

1. Press and hold  to turn the phone on. The phone will display the welcome animation.
2. Enter your PIN code and press  to confirm.

 The PIN (Personal Identification Number) is the password provided by your network operator. You need this password in order to use the SIM card.



If you enter the PIN incorrectly three times in a row, the SIM card will be locked. You must now enter the PUK (Personal Unblocking Key) for that SIM card in order to unlock it. Please contact your network operator to obtain a PUK.

-  To activate/disable PIN password authentication, go to **Settings > Security > PIN Code > PIN1 Code > Settings**. See page 73.
3. When the PIN code entered has been accepted, the phone will automatically search for the designated network. This search process may take a few seconds.
  4. The idle screen will be displayed, as well as network signal strength and the name of the network operator. You can now use the phone.
-  If the phone is not able to detect the designated network, or links to a network that you are not authorized to use, the signal strength meter will show no bars. You will only be able to make emergency calls.

## The miniSD Card

Your phone features a miniSD slot designed specifically for use with the miniSD card, a removable flash memory card intended to add greater storage capacity to your phone.

The miniSD card enables you to store multimedia data such as images, photos, MP3 audio files, ring tones, and videos.

### Installing the miniSD Card

1. Lift the cover.
2. Insert the miniSD Card into the slot. Ensure that the card's metal contacts face downwards.
3. Close the cover.



 Your phone does not support a miniSD card which is on **FAT32** or **NTFS** format.

### Removing the miniSD Card

1. Lift the cover.
2. Press the miniSD card to release it.

## 2 Getting to Know Your Phone

### Your Phone at a Glance

Front and side views

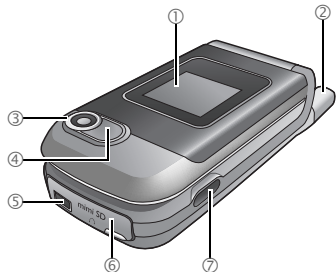

- ① sub display
- ② Antenna
- ③ Front Camera
- ④ Camera flash
- ⑤ Charger socket
- ⑥ Rubber cover
- ⑦ IrDA port

To view what is behind the rubber cover, lift the cover and twist it to the left.

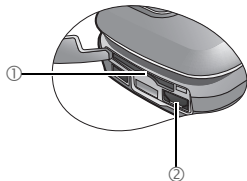

- ① miniSD slot
- ② Hands-free headset /  
Data cable jack



## Side and back views

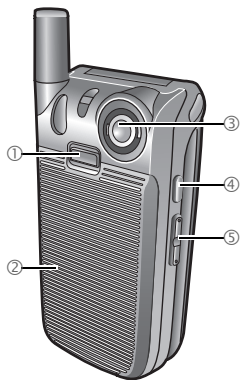

- ① Battery latch
- ② Battery
- ③ Speaker
- ④ Camera hot key
- ⑤ Volume key

## Front open view

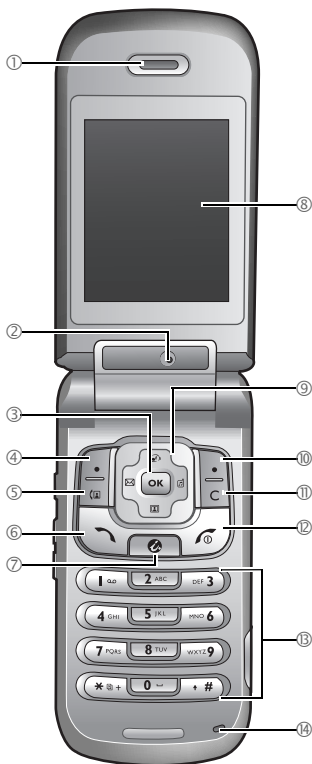





- ① Earpiece
- ② Near Camera
- ③ OK key
- ④ Left soft key
- ⑤ Video call hot key
- ⑥ Dial/Answer key
- ⑦ WAP key
- ⑧ Main Display
- ⑨ Navigation key
- ⑩ Right soft key
- ⑪ Clear key
- ⑫ Power on/off key
- ⑬ Alphanumeric keys
- ⑭ Microphone

## Sub Display

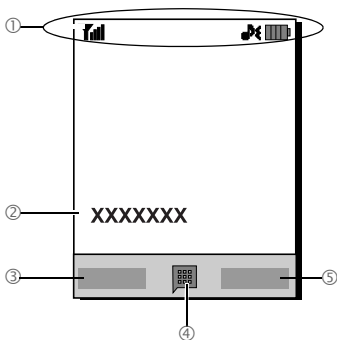
When the flip is closed, the sub display's status bar will show icons for network strength, battery power, the current time and the current profile in use. The sub display will also alert you to incoming calls, new messages and missed calls.

## Idle Screen























- ① Status bar
- ② Name of network operator
- ③ Press  to enter the indicated function
- ④ Press  to enter the main menu.
- ⑤ Press  to enter the indicated function.



- To set the wallpaper of the display, go to **Settings > Display > Wallpaper**. Alternatively, you can go to **Media Center > Images**. See page 56 and page 67.
- To set the current time and date, as well as the format to be shown, go to **Settings > Date & Time**. See page 65.





## Icons in the Status Bar











Icon	Function	Description
	Signal strength	Signal strength of the network. The more bars indicated, the stronger the signal.
	Battery status	Shows the current level of battery power. The more bars indicated, the more power remains.
	GPRS in use	Appears when GPRS has been activated.
	3G in use	Appears when 3G has been activated.
	GPRS Connection	Appears when the phone is connecting to a GPRS network.
	3G Connection	Appears when the phone is connecting to a 3G network.
	Bluetooth	Appears when Bluetooth is turned on.
	SMS Message	Appears when you have new or unread SMS messages. Appears in red when your SMS messages are full.
	MMS Message	Appears when you have new or unread MMS messages. Appears in red when your MMS messages are full.
	WAP message	Appears when you have new or unread WAP messages.
	E-mail	Appears when you have new or unread e-mail messages. Appears in red when your e-mails are full.



Icon	Function	Description
	Voicemail	Appears when you have new voicemail messages (this icon will only appear if the function is supported by your network operator).
	Alarm	Appears when the alarm is turned on.
	Normal	Shows that the <b>Normal</b> profile is activated.
	Flight Mode	Appears when the <b>Flight</b> profile is activated.
	Headset	Appears when a headset is connected to the phone.
	Meeting	Shows that the <b>Meeting</b> profile is activated.
	Silent	Shows that the <b>Silent</b> profile is activated.
	Outdoors	Shows that the <b>Outdoors</b> profile is activated.
	Divert	Appears when the call divert is activated.
	Roaming	Roaming is activated (not your regular network).

## Using the Keys in Idle Mode



 In this user manual, "long-press" means to press and hold down a key for about two seconds. "Press" means to press a key and release immediately.



Key	Commands and functions
	<b>Power On/off key</b> <ul style="list-style-type: none"><li>• Long-press to turn the phone on or off.</li><li>• Press this key to end a call, reject an incoming call, or to cancel a dialing.</li></ul>
	<b>Send/Answer key</b> <ul style="list-style-type: none"><li>• Press to send or answer a call.</li><li>• Press to access the call record list.</li></ul>
	<b>Left soft key</b> <ul style="list-style-type: none"><li>• Press to perform the function indicated on the display.</li></ul>
	<b>Right soft key</b> <ul style="list-style-type: none"><li>• Press to perform the function indicated on the display.</li><li>• Long-press to turn the silent profile on or off.</li></ul>
	<b>OK key</b> <ul style="list-style-type: none"><li>• Press to open up the main menu.</li></ul>

Key	Commands and functions
	<p><b>Navigation key</b></p> <ul style="list-style-type: none"> <li>• Press  to go to iMusic Store to download music.</li> <li>• Press  to create a new SMS message.</li> <li>• Press  to access Media Center.</li> <li>• Press  to access Profiles menu.</li> </ul>
	<p><b>Video call hot key</b></p> <ul style="list-style-type: none"> <li>• Press to answer a video call.</li> </ul>
	<p><b>WAP hot key</b></p> <ul style="list-style-type: none"> <li>• Press to access WAP and more services that your network operator provides.</li> </ul>
	<p><b>Asterisk key</b></p> <ul style="list-style-type: none"> <li>• Press this key to enter an asterisk " * " .</li> <li>• To make an international call, long-press this key until the display shows "+", then enter the recipient's country code, area code and phone number.</li> </ul>
	<p><b>Voicemail key</b></p> <ul style="list-style-type: none"> <li>• Long-press to dial your voicemail number.</li> </ul>
	<p><b># key</b></p> <ul style="list-style-type: none"> <li>• Press to enter "#".</li> <li>• For extensions: After entering a phone number, long-press to enter a "P" and then enter the extension number.</li> </ul>

Key	Commands and functions
	<b>Alphanumeric keys</b> <ul style="list-style-type: none"> <li>• Press to enter digits.</li> </ul>
	<b>Volume key</b> <ul style="list-style-type: none"> <li>• Long press the upper or lower key to adjust the volume.</li> </ul>
	<b>Camera hot key</b> <ul style="list-style-type: none"> <li>• Long press to activate the camera mode.</li> </ul>

## Menu Navigation

1. In idle mode, press  to bring up the main menu.
2. Use the scroll key to move up, down, right or left through the menu, for example, scroll to **Settings**, and press  to enter its menu.
3. Use the scroll key to scroll to a submenu, for example **Profiles**, and press  to enter the submenu item.

 You can also access a menu item by pressing the corresponding menu number. In the above example, press  to access **Profiles**.



## Using Your Phone

### Call Functions



#### Making a Phone Call

In idle mode, enter the phone number. Press  to dial your call.

#### Ending a Phone Call

To end a call, press  or close the flip. The display will show the total call time, and then return to idle mode.

#### Answering a Phone Call

To answer a call, press . Or, open the flip. Also you can answer a call by pressing the side key .

 If you wish to change the way of answering a call, go to **Settings > Call Settings > Answer Mode**.

#### Rejecting an Incoming Call

To reject an incoming call, press  or close the flip. Also you can reject a call by long-pressing the upper volume key. To turn off the ring of the incoming call, long-press the lower volume key.



## Adjusting the Volume

During a call, if you want to adjust the speech volume, you can press the volume key on the left side of the phone.

 Please note:

- When there is an incoming call, you can mute the ring tone by long-pressing the lower portion of the volume key.
- Adjusting speech volume only works during a call.



## Making an International Call

1. Enter the outgoing international call code, or long-press  until "+" appears on the display.
2. Enter the recipient's country code, area code and phone number. Dial the call by pressing .

## Making an Emergency Call

To call emergency services, enter 112 (the international emergency number) and then press  to dial the call. You can make an emergency call even if your phone is locked or cannot access your network, or there is no SIM card inserted, so long as you are within range of a network of the type supported by your phone.

## Dialing an Extension Number

After you enter a telephone number, long-press  until "P" appears on the display. At this point, you can enter the desired extension number, and then press  to dial it.

## Listening to Voicemails

Long-press  to dial the voicemail phone number and listen to your voicemails.

 Please note:

- If the network vendor supports it, the voicemail icon will appear on the display when you have new voicemails.
- If the voicemail number is not stored in the memory, you will not be able to access your voicemail by long-pressing . In this case, you will need to manually set the number by going to **Messages > Voicemail > Set Number**.



## Operations During a Call

 The following options marked with an asterisk (\*) are dependent on network support and may require a subscription.







### Loudspeaker

During a call, press  to turn on the loudspeaker.

### Mute

Press  (**Mute**) to turn off the microphone. The person on the other end of the line will not be able to hear your voice. To restore the microphone's function, press  (**Unmute**).

## Putting a Call on Hold\*

- When the only call is active:
  - a. Press  (**Hold**) to hold this call.
  - b. Press  to end this call.
- When the only call is on hold:
  - a. Press  (**Unhold**) to resume the call.
  - b. Press  to end this call.
- When there is an active call and a call on hold.
  - a. Press  (**Swap**) to resume the call that is on hold, and put the active call on hold.
  - b. Press  to show a list of calls that you can end.





## Making a Second Call\*

Enter a phone number, or select one from the phone number or call record, and then press  to dial it. The currently active call will automatically be placed on hold.

## Call Waiting\*

If there is an incoming call while you are on the phone, the phone will notify you with a call waiting tone. If you want to

- Answer the waiting call: Press . The currently active call will automatically be placed on hold. However, if there is already another call on hold, a list will appear allowing you to select a call to end and then answer the waiting call.

- Reject the waiting call: Press  or  (**End**). Pressing  (**End**) will immediately reject the waiting call; pressing  will bring up a list allowing you to select a call to end.

## Call Menu

If you press  during a call, it will bring up a call menu which provides a number of functions during a call.

 Items marked with an asterisk (\*) depend on network support and may require a subscription.

### Phone Book

Allows you to search for a contact in the phone book.

### Calls

Allows you to view missed, received, and dialed calls.

### Use Headset

Allows you to search for a bluetooth headset device.

### Conference

Conference calls allow you to converse with more than one party at a time.

#### Join

Adds a party that is on hold to the current conference call, or isolates a single party in a conference call and puts all other parties on hold.

#### Swap\*

Toggles the call status.

## **Transfer**

Allows two parties to connect, while ending one's own call (one of the two parties may be involved in an active call while the other is either on hold or being dialed), so as to allow the two parties to have their own call.

## **Send DTMF**

When the phone is connected with other devices or services, you can send DTMF (Dual Tone Multi-Frequency) strings. DTMF strings are keypad tones that can be sent via the microphone as you dial another number. Your phone will emit the tones in order to communicate with answering machines, pagers, computerized telephone services, and so forth.

Enter the number and then press  to send the DTMF string.

## **End Call**

### **End All**

Ends all calls, whether active or on hold.

### **End Active**

Ends only the active call.

### **End Hold**

Ends only a call or calls on hold.

### **End One**

Ends only a single call by the number or the contact.

## **Hold/Unhold/Swap**

Toggles the call status.

## **Mute**

Activates/cancels the silent mode.

## **Text**

Allows you to read or write an SMS message during a call. For details, see page 37, "SMS".

## **MMS**

Allows you to read or write an MMS message during a call. For details, see page 40, "MMS".

## **Calculator**

Allows you to use the calculator. For details, see page 61, "Calculator".

## **Making a Video Call**



A video call allows you to have a real-time, two-way video between you and the recipient. The video image captured either by the rear or the front camera will be shown on the recipient's phone.



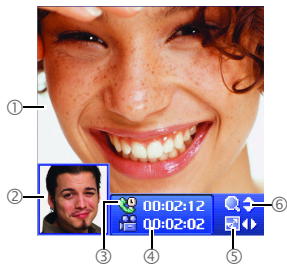

To be able to use the video call services, you need to have a USIM card and be in the coverage of a UMTS network. For subscription and details of video call services, please contact your network operator or service provider for details.

To make a video call, enter the phone number and then press  to make a video call. The video call is successfully connected when you can see the two video images and can hear the sound through the speaker. For details about video call settings, see page 23, "Video Call Settings".



- ① Video call main display
- ② Video call sub display
- ③ Call time
- ④ Video elapsed time
- ⑤ Press  to switch between main and sub display
- ⑥ Press  to zoom in or out your video image.

## Answering a Video Call

To answer a video call, press  and then press  (**Yes**) when there is a message showing that you have an incoming video call.

## Video Call Settings

### Changing the Display

During a video call, press  and select **Display**.

- **PIP:** PIP(Picture-in-Picture) allows you to view the caller's and the recipient's video images simultaneously on the display. One appears in the main display and the other appears in the sub display. Press  to switch displays.
- **Full:** Only the caller's or the recipient's video image will be shown.



## Changing the Image Source

During a video call, press  and select **Image Source**.

- **Near Camera:** Select this option and video image will be captured by the near camera.
- **Front Camera:** Select this option and video image will be captured by the front camera.
- **Camera Off:** Select this option and the recipient will not be able to see your video image.
- **Multimedia:** To select an image or video to be shown to the recipient.

## Options During a Video Call

### Record

During a call, press  (**Record**) will record both the caller and the recipient's videos on the display.

### Call Menu

If you press  during a call, it will bring up a call menu which provides a number of functions during a call.

 Items marked with an asterisk (\*) depend on network support and may require a subscription.

### Phone Book

Allows you to search for a contact in the phone book.

### Calls

Allows you to view missed, received, and dialed calls.

## **End Call**

### **End All**

Ends all calls, whether active or on hold.

### **End Active**

Ends only the active call.

### **End Hold**

Ends only a call or calls on hold.

### **End One**

Ends only a single call by the number or the contact.

## **Record**

Records both the caller and the recipient's videos on the display.

## **Mute**

Activates/cancels the silent mode.

## **Text**

Allows you to read or write an SMS message during a call. For details, see page 37, "SMS".

## **Calculator**

Allows you to use the calculator. For details, see page 61, "Calculator".

## **Image Source**

See page 24, "Changing the Image Source".





## **Display**

See page 23, "Changing the Display".

# Phone Book

## Adding Contacts to the Phone Book



 The capacity of a phone book on your SIM card depends on the type of SIM card provided by your network operator.

1. In idle mode, enter the phone number that you want to save, then press  (**Option**) and select **Save**.
2. Select the memory where the contact is to be stored. Select from either **Add to SIM** or **Add to Phone**.
3. Scroll to the data field that you want to edit, and then press  to enter data.
4. Press  to return to the phone book data field after filling the entry.
5. Press  (**Save**) to save the entries you have entered.

### Phone book entries on SIM card memory





Name	The contact's name.
Number	The contact's phone number.
Caller Group	Used to select a caller group for the contact. To define each caller group, go to <b>Phone Book &gt; Caller Groups</b> . See page 52.

## Phone book entries on phone memory

Name	The contact's name.
Mobile Number	The contact's mobile phone number.
Home Number	The contact's home phone number.
Office Number	The contact's office phone number.
Email	The contact's e-mail address.
Caller Group	Used to select a caller group for the contact. To define each caller group, go to <b>Phone Book &gt; Caller Groups</b> . See page 52.
Image ID	Used to set the image or video that will appear on the display when there is an incoming call from the contact.  The image/video set in this field will replace the image/video associated with the contact's caller group, if any.
Ring ID	Used to set a ring tone for the contact. When there is an incoming call from the contact, the phone will play this ring tone.  A ring tone set in this field will replace the one associated with the contact's caller group, if any.
Memo	Used for notes about the contact.



## Finding Contacts in the Phone Book

1. In idle mode, press  (**Names**) to display contacts stored in the Phone Book.
  - Press the alphanumeric key that corresponds to the first letter of the name you wish to locate the appropriate number of times.
  - If necessary, scroll to the contact you want.



 The icon that precedes the contact's name appears differently according to the memory, SIM or phone, that the contact is saved to.
2. When you have found the entry you want, you can
  - Press  to dial the number. If the entry has more than one phone number, then you will be prompted to select a number.
  - Press  (**Option**) to access a list of options including **Video Call**, **Call**, **Send Message**, **New**, **Edit**, **Delete**, **Copy to Phone/Copy to SIM**, or **Delete All**.
  - Press  to view the contact's details.

## Last Missed, Dialed, and Received Calls

There are two ways you can view the last missed, dialed, and received calls on your phone.



1. If there have been any missed calls, the display will show a missed call message along with the number of calls that were missed. Press  to view the missed call number.
2. In idle mode, press  to view the list of the most recent missed, dialed, and received calls.

Scroll to the number you want and then

- Press  to call back.
- Press  (**Option**) and select your desired function.

## Using the Silent Profile

In idle mode, you can long-press  to activate the silent profile. Once it is activated, the phone will alert you to an incoming call by vibrating without ringing.



1. When you long-press  to activate the silent profile, the phone will vibrate for one second. The icon  will appear in the status bar.
2. To turn off the silent profile, long-press .

 To select or define a profile, go to **Settings > Profiles**. See page 65, "Profiles".





## Camera

Your phone features a digital camera that allows you to take a picture, and then set it as a wallpaper or send it through a MMS message.



### Taking Pictures

1. In idle mode, press  (**Camera**) or long-press the quick camera access key  to activate the camera mode.

 You can also activate camera mode by going to **Entertainment > Camera**.

2. The viewfinder is then displayed. The number at the top right corner indicates the number of pictures remained to be taken. The number varies according to the image size you choose.
3. Press  (**Option**) to access options of settings. For details of various settings, see page 31, "Camera Settings". Press  (**Back**) to return to viewfinder.
4. Press  to bring up more options of settings. For details of those settings, see page 31, "More Camera Settings".
5. Press  to take a picture. The picture is now saved to the phone or to the miniSD automatically according to the setting you made.

6. After taking your picture, press  (**Option**) to access a list of options, see page 32, "Managing Your Pictures".

 To take a self-portrait, close the flip and long press the quick camera access key  to activate the camera mode. Press the key  when you are ready to take a picture.

## Camera Settings

1. Press  (**Option**) to access options of settings.

- **Size:** Allows you to set the size of the image.
- **Quality:** Sets the quality sharpness at which the photo is taken.
- **Turn On Flash/Turn Off Flash:** Allows you to set the flash on or off.
- **Switch To Indoor/Switch To Outdoor :** Allows you to adjust the camera settings to suit indoor or outdoor environments.
- **Contrast:** Allows you to adjust the contrast level from -5 to +5.
- **Turn On Sound/Turn Off Sound:** Allows you to turn the shot tone on or off.
- **Save To miniSD/Save To Phone:** Determines where your photos will be saved to.
- **Go To Images:** Goes to the **Images** folder where photos are stored.

2. Scroll to the desired option and then press  to save the setting.

## More Camera Settings

Press  to bring up more options of settings. Scroll left or right to select one of the options from the following:



## Digital Zoom

Scroll up or down to zoom in or out.

## White Balance

Allows you to load preset settings for specific lighting conditions. Scroll up or down to select one option.

## Brightness

Scroll up or down to increase or decrease brightness.

## Color Settings

Enables you to apply a tone or color to your picture to create an artistic effect. Scroll up or down to select an option.

## Managing Your Pictures







After taking your picture, press  (**Option**) to select from one of the following:

- **Send:** Allows you to send the picture through MMS, e-mail, or InfraRed.
- **Delete:** Allows you to delete the picture.
- **Set as:** Allows you to set the picture as a wallpaper or a caller image.
- **Rename:** Allows you to rename the taken picture.
- **Go To Images:** Takes you to the **Images** folder.

## Camcorder

Your phone features a camcorder for you to shoot video clips. You can then send the video clips through MMS messages.

### Shooting a Video Clip

1. To activate the video mode, go to **Entertainment > Camcorder**.
2. The viewfinder is then displayed.
3. Press  (**Option**) to access options of settings. For details of various settings, see page 34, "Camcorder Settings". Press  (**Back**) to return to viewfinder.
4. Press  to bring up more options of settings. For details of those settings, see page 34, "More Camcorder Settings".
5. Press  to start recording. Press  again to stop. The video is now saved to the phone or to the miniSD automatically according to the setting you made.
6. After recording your video clip, press  to play your video or press  (**Option**) to access a list of options, see page 35, "Managing Your Videos".

## Camcorder Settings

1. Press  (**Option**) to access options of settings.

- **Size:** Allows you to set the size of the video clip.

 Video is set to **MMS Video Clip** by default. When you finish recording, you can directly send the video to others in a MMS message.

- **Quality:** Sets the quality sharpness at which the video is captured.
- **Contrast:** Allows you to adjust the contrast level from -5 to +5.
- **Save To miniSD/Save To Phone:** Determines where your photos will be saved to.
- **Go To Videos:** Goes to the **Videos** folder where videos are stored.

2. Scroll to the desired option and then press  to save the setting.

## More Camcorder Settings

Press  to bring up more options of settings. Scroll left or right to select one of the options from the following:

### Digital Zoom

Scroll up or down to zoom in or out.

### White Balance

Allows you to load preset settings for specific lighting conditions. Scroll up or down to select one option.

### Brightness

Scroll up or down to increase or decrease brightness.

## Color Settings

Enables you to apply a tone or color to your video to create an artistic effect. Scroll up or down to select an option.

## Managing Your Videos

After recording your video clip, press  (**Option**) to select from one of the following:

- **Play:** Plays the video.
- **Send:** Allows you to send the picture through MMS, e-mail, or InfraRed.
- **Delete:** Allows you to delete the picture.
- **Rename:** Allows you to rename the taken picture.
- **Go To Videos:** Takes you to the **Videos** folder.

## MP3 Player

Your phone features a MP3 player which allows you to play your favorite music on-the-go. Go to **Entertainment** > **MP3 Player** to bring up the MP3 player.

 The MP3 Player can only play audio files saved in .mp3 format.

## Building a play list

You need to build a play list at the first time you use the MP3 payer.

1. On the MP3 player screen, press  (**Option**) and select **Edit Play List** to build your play List.

2. Scroll to the song you want to add, then press **OK** to select the song. Repeat the step to include multiple songs in the play list. Press **Done** to confirm your choices.

## Playing the music

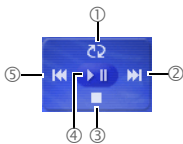

- 1 Press **Repeat** to set the play mode-repeat once **1**, repeat all **All**, random **OC** or off **OFF**.
- 2 Press **Next** to play the next song; Long press to fast-forward 10 seconds of the song.
- 3 Press **Stop** to stop the song.
- 4 Press **OK** to play or pause the song.
- 5 Press **Previous** to play the previous song; Long press to rewind 10 seconds of the song.

## Uploading music to your phone

Upload music to your phone is simple by using the supplied USB cable and the miniSD card.

1. Install the supplied software CD and install the software.
2. Ensure that your miniSD card has been inserted into your phone.
3. Plug the USB port of the cable into the USB slot of your PC, and the handset port of the cable into the cable jack of your phone.
4. Select **PC Sync**, or **miniSD Reader**.
5. Simply drag and drop the music files from your PC to the music folder on your miniSD card. If your miniSD card is empty, you need to create a folder named "Music" in the miniSD card.



6. Once you have uploaded music files to the miniSD card, unplug the USB cable.
7. Go to **Entertainment** > **MP3 Player** and begin building a play list of your own. See page 35, "Building a play list".

## Messages









Your phone supports various messaging services including SMS (Short Messaging Service) and MMS (Multimedia Messaging service). SMS allows you send text messages, while MMS enables you to send photos, colored images and music through your phone. You must have a subscription that supports MMS. Please contact your network operator for details.

### SMS



#### Receiving a New Message





1. When you receive a new message, " 1 New Message" will appear on the display with a tone or vibration if selected.
2. To read the message, press . To manage the message, press  (**Option**). For details about managing received messages, see page 38, "Managing Inbox".

## Creating a New Message



1. To bring up the message editing screen, press  in idle mode, or go to **Messages** > **SMS** > **New**. Use the alphanumeric keys to enter text.  
 For information on the input method, see page 46, "Input Modes".
2. When you have finished editing the text, press  or press  (**Option**) and select **Send**.
3. Enter a phone number directly or press  (**Contacts**) to select a contact from your phone book.
4. Scroll to the desired contact and press  to select. Press  (**Done**) to confirm selection.
5. Press  to send.

## Managing Inbox

Your phone saves incoming messages in the Inbox. To manage Inbox messages, go to **Messages** > **SMS** > **Inbox**. A list of messages received appear. To view a message, scroll to it and press . Press  (**Option**) and select your desired function.

 Read messages saved on the phone or on the SIM will be marked by  or . Unread messages saved on the phone or on the SIM will be marked by  or .

## Managing Sent Items

Sent folder preserves messages that were successfully delivered. To manage Sent messages, go to **Messages > SMS > Sent**. To view a message, scroll to it and press . Press  (**Option**) and select your desired function.

## Managing Drafts

Drafts folder contains messages that you chose to save. To manage drafts, go to **Messages > SMS > Drafts**. To edit a message, scroll to it and press .

## Managing Archive

Archive stores the messages you have saved to archive.

## Cleaning Up Messages

To clean up messages, go to **Messages > SMS > Delete**. You can choose to delete message by category.

## Settings



Your phone is already set up to send or receive messages. Contact your network operator for details.







## MMS

In order to use MMS, you have to subscribe to a GPRS or an UMTS network service, and the MMS service provided by your operator. Contact your operator for details about MMS settings.



### Reading a Message

1. When you receive a new MMS message, " 1 New MMS" will appear on the display with a tone or vibration if selected. When you have successfully downloaded the MMS message, press  to open the MMS message. Press  (**Option**) and select your desired function.



### Creating a New Message

1. To write a new MMS message, go to **Messages > MMS > New**. Use the alphanumeric keys to enter text.
2. To insert objects into the message, press  (**Option**) and select **Insert**. The option allows you to insert images, videos, audio files, a new picture, a new page, a business card of a contact in your phone book, or a scheduled event in your calendar.
3. After you have finished creating the MMS message, press  to enter the recipient's phone number, or press  (**Contacts**) to select contacts.
4. Press  to send the message.

## Managing Inbox

Your phone saves incoming messages in the Inbox. To manage Inbox messages, go to **Messages > MMS > Inbox**. A list of received messages appear. To view a message, scroll to it and press . Press  (**Option**) and select your desired function.

## Managing Sent Items

Sent folder preserves messages that were successfully delivered. To manage Sent messages, go to **Messages > MMS > Sent**. To view a message, scroll to it and press . Press  (**Option**) and select your desired function.

## Managing Drafts

Drafts stores messages you have saved to Drafts. To manage drafts, go to **Messages > MMS > Drafts**. To edit a message, scroll to it and press .

## Notifications

The notification will be saved at this folder if you select **Notify Me First** at **Messages > MMS > Settings > Notify**. Besides, for any reason that you are unable to receive MMS messages, a notification will be stored at this folder as well.

## Managing Archive

Archive stores the messages you have saved to archive.

## Media Downloads

A shortcut that takes you to the site for downloads.

## Cleaning Up Messages

To clean up messages, go to **Messages > MMS > Cleanup**. You can choose to delete message by category.

## Settings

To set up advanced settings for MMS, go to **Messages > MMS > Settings**.

### MMS Server

Configures the MMS server used for sending and receiving MMS messages.

### Size Limit

Sets the maximum size for a message that the phone receives. If an incoming message exceeds this size, the phone will not be able to download that message.

### Notify

Select **Auto Download** if you want an incoming MMS to be immediately downloaded. Select **Notify Me First** you can decide whether to download the MMS upon the notification.

### Delivery

Asks the recipient to return a delivery/read confirmation after you send a MMS message to someone.

### Expiry

Sets the length of time your outgoing MMS message stays on the server before it reaches the recipient successfully.

## Security Check

Select **Reject By Sender** to reject MMS messages from the senders you listed in **Filter**.

## Filter

Allows you to list the senders whose MMS messages are to be rejected.



## E-Mail



In order to use e-mail to send and to receive messages, you need an e-mail account and access to a GPRS or an UMTS network.

### Receiving New Messages

To connect to the e-mail service and retrieve new messages, go to **Messages > E-Mail > Receive**. The e-mail messages that you retrieved will be saved in **Inbox**.

### Creating a New Message

1. To write and send a new e-mail message, go to **Messages > E-Mail > New**. To edit the message content, scroll to the **Content** and then press . Press  (**Option**) to execute the following:
  - **Insert Text:** Insert preset texts to the message.
  - **Attachments:** Press  (**Option**) and select **Insert**. The option allows you to insert images, videos, audio files, a new picture, a new page, a business card of a contact in your phone book, or a scheduled event in your calendar.

2. After you finish creating the e-mail message, press  to return to the main list.
- **To:** Enter the recipient's e-mail address or select a contact's e-mail address from your phone book by pressing  (**Contacts**). To send your message, this field can not be left blank.
  - **Subject:** Allows you to enter text for the subject.
  - **Content:** Contains the message that you created.
  - **Cc:** Allows you to send the message as a carbon copy to others.
  - **Bcc:** Allows you to send the message as a confidential carbon copy to others.
  - **Priority:** Allows you to set the priority for this message.
3. Press  (**Option**) and select **Send** to send the message.

## Settings

For your e-mail connection settings, please contact your e-mail service provider for details. To configure the settings manually, press  (**Option**) and select **Add**.

## Voicemail

### Get Voicemail

Dials the voicemail number provided by your network operator to access your voicemail box.

 In idle mode, long-press  to access your voicemail box.

## Set Number

Allows you to set your voicemail phone number.

## Broadcast

Cell broadcast messages are messages that your network operator broadcasts to all phones within a particular area. These messages are broadcast in numbered channels. For example, channel 030 might be for local weather, 060 for traffic reports, 080 for information about local hospitals, taxis, pharmacies, and so forth. You can receive cell broadcast messages that your network operator broadcasts, and select your preferred topics and languages.

 For more information about available channels and a list of the information they provide, contact your network operator.

### Set Status

To activate the cell broadcast feature, set this option to **On**.

### Topics



The topics listed in the **Topics** list represent the broadcast information that you have selected to receive from your network operator.

### Language



You can limit the cell broadcast information that you receive from your network operator to a specific language.

## Input Modes

When an editing screen is displayed, the current text input mode is indicated in the upper right corner of the screen. The phone has the following input modes.

	Letters input mode
	Predictive input mode
	Numeric input mode



### Changing the Text Input Mode

Press  to change the input mode. Press  to open the symbols table. Long-press  to switch to lower or upper case letters.

## Letter Input Mode (ABC)



### How to use the letter input mode

- You must press the key corresponding to the desired letter the correct number of times in order to enter the letter you want. Display letters for entry according to the order shown on each key. Pressing a key once will display the first letter listed on the key, while pressing it twice will display the second letter, and so on.
- When you have entered a letter and wish to enter the next letter, either wait for two seconds until the cursor moves to the next text entry position, or immediately press the key for the next letter.
- Short press  to enter a space before beginning a new word.

- While entering text, use the scroll key to move the cursor. Press  once to delete a character; long-press  to delete all entered text.











## Predictive Input Mode (iTap)

### How to use iTap

- Press each key associated with the letter you want to enter only once. The letters you have entered appear on the display. The candidate words will change with each key you press.
- If the first highlighted candidate word is the wrong word, scroll to view other candidate words and locate the desired word.
- Once the correct word is located, press  to enter the word.
- While entering text, use scroll key to move the cursor. Press  once to delete a character; long-press  to delete all entered text.



### Example of using iTap

To enter "Come home" using iTap:





1. Press     to select C, o, m, e.
2. Press  to enter "Come". Press  to enter a space.
3. Press     to enter "home".
4. Since "good" is not the word that you wish to enter, scroll to the next candidate word "home".
5. Press  to enter "home".



## Numeric Input Mode (123)

The numeric input mode allows you to use the alphanumeric keys  to  to enter numbers.

## Symbol Input Mode

To open symbol table, press . Press  to open the next page. Press  to place the symbol in the text. Press  to hide the table.

## Using the Bluetooth

The Bluetooth® word mark and logos are owned by Bluetooth SIG, Inc. and any use of such marks by BenQ Corp. is under licence.





Other trademarks and trade names are those of their respective owners.

Bluetooth QDID (Qualified Design ID): B02327

Your phone features the bluetooth function that allows you to have a wireless connection between your mobile phone and your bluetooth headset.

## Establishing Connection with Your Bluetooth Headset

1. Go to **Tools > Connections > Bluetooth > Turn On** to turn on the Bluetooth. The Bluetooth icon  appears on the idle screen.
2. You will be asked to search and to add Bluetooth devices, press  (**Yes**) to begin searching. Make sure that your Bluetooth headset is switched on and is in "pairing mode".

3. When a list of devices appear on the screen, select a device to connect to and press .
4. When a message pops up, press  (**Yes**) to connect.
5. Enter the Bluetooth headset passkey and press .
-  Please check the user manual of your bluetooth headset for this passkey.
6. When the passkey is accepted, the headset is paired and is connected with your phone.

## Organizing your Devices

Go to **Tools > Connections > Bluetooth > Devices**. Select a device from the list, and press  (**Option**) to access a list of options.

## PC Synchronization and Data Transfer

1. To connect your mobile phone to your PC with the cable supplied, plug the USB port of the cable into the USB slot of your PC, and the handset port of the cable into the cable jack of your phone.
2. The phone will display a **USB Connection** menu. Select an option from one of the following:

- **miniSD Reader**

To use your mobile phone as a removable storage device to transfer file, select this option.



When copying a file from your computer to the miniSD card or to the phone, you must place the file in the folder intended for this type of file. For example, an MP3 file must be placed in the **Music** folder in order to be successfully used in the phone.

- **PC Sync.**

To synchronize the phone with your computer to transfer phone book data or calendar events, select this option.



Before start to perform data synchronization function, make sure you have installed onto your computer the software tool designed for use with the phone.

3. The icon  will appear on the Windows status bar at the bottom right of the computer screen, indicating that the connection is successful.

## **Menus**

The phone features various functions and they are organized in the menus and sub-menus. The main menu consists of nine categories. Each category has related sub-menus.

For information about navigating menus, see page 15, "Menu Navigation".



## **Phone Book**

### **List**

Used to display all the contacts in your Phone Book.

### **Find**

Used to locate a contact in the Phone Book. Enter the first letter to view a list of contacts begin with the letter. Scroll to the contact you want to find. See page 28, "Finding Contacts in the Phone Book" for details about what to do after locating a contact.

### **Add**

Used to add a new contact to the Phone Book. See page 26, "Adding Contacts to the Phone Book" for details.

## Copy

Used to copy contacts stored in the phone to SIM card, or copy contacts stored in the SIM card to phone. You can also select to copy individual contact.

## Delete

Deletes a contact from the Phone Book. You can delete one contact at a time, or delete all contacts at once.

## Caller Group

Caller groups are combinations of phone settings used to identify a particular group of contacts. Press  (**Option**) to select the ring or image that a particular caller group belongs, or to rename the caller group.

## Own Number

This option allows you to store your phone number and name.

## Memory

Shows you the number of entries that have been stored and the maximum entries that can be stored, on the SIM and on the phone.



## Messages

For the description of features available in the messages menu, see page 35, "MP3 Player".



## Calls

This menu includes a list of your missed calls, dialed calls, and received calls. Call costs and time are also recorded.

### Missed

Shows your most recent missed calls.

See page 28, "Last Missed, Dialed, and Received Calls" for details.

### Received

Shows your most recent received calls.

See page 28, "Last Missed, Dialed, and Received Calls" for details.

### Dialed

Shows your most recent dialed calls.

See page 28, "Last Missed, Dialed, and Received Calls" for details.

### Cleanup All

Deletes all of the call records.

## Display

### Show Call Timer

Select **Active** will set your phone to display call timer during a call. Select **End Call** will set your phone to display call timer when a call ends.

### Show Call Cost

 This feature is only accessible if supported by your network operator.

Select **End Call** will set your phone to display cost information when a call ends.

## Duration and Cost

 This feature is only accessible if supported by your network operator.

Shows the duration and cost of the calls you have made. To reset the data, scroll to the desired category and press  (**Reset**).



## Games

Your phone features a number of entertaining applications and games. You can play the games that embedded in the phone, or download Java applications directly to your phone.

 To adjust volume, return to idle mode and press the upper or lower volume key.

## Settings

### Default URL

Allows you to set the default site for downloading games to your phone.

### Download Size

Allows you to set the size limit for each game you download.

### Memory

Shows the amount of memory available for Java applications.

### Java Version

Shows the version of the Java virtual machine on your phone.



## Entertainment

### Camera

For information about using the camera, see page 30, "Camera".

### Camcorder

For information about using the camcorder, see page 33, "Camcorder".

### MP3 Player

For information about using the MP3 player, see page 35, "MP3 Player".







## Media Center

### Images

Images stores images that have been saved to the phone or to the miniSD card.

1. Scroll to the desired image.
2. Press  to display the selected image. Scroll up or down to display the next or previous picture.
3. Press  (**Option**) to perform the following:



 The following options marked with an asterisk (\*) are not applicable to DRM(Digital Rights Managements) objects.

- **Send\***: Allows you to send the image in a MMS message, in an e-mail, or by infrared.
- **Delete\***: Allows you to delete the image.
- **Set as**: Allows you to set this image as a wallpaper or as an image caller ID for a specified contact or a new entry.
- **Edit\***: Allows you to add frames or stamps, or to rotate the picture.
- **Move To miniSD/Move To Phone\***: Allows you move the image from phone to miniSD, or from miniSD to phone.
- **Copy to miniSD/Copy to Phone\***: Allows you to copy the image from phone to miniSD, or from miniSD to phone.

- **Slide Show:** Allows you to view all the images as a slide show. Press  to stop playing slides.
- **Rename\*:** Allows you to rename the images.
- **Details:** Shows details of the image.



## Videos

Videos stores video clips captured by the camera or transferred from other devices. The video formats supported by the phone are .mp4 and .3gp.

1. Scroll to the desired video clip.
2. Press  to start playing the video.
3. Press the volume key to adjust volume of the video.
4. When playback stops, press  (**Option**) to perform the following:
  - **Send:** Allows you to send the video in a MMS message, in an e-mail, or by infrared.
  - **Delete:** Allows you to delete the video.
  - **Set As Image ID:** Allows you to set this video as an image caller ID for a specified contact or a new entry.
  - **Move To miniSD/Move To Phone:** Allows you move the video from phone to miniSD, or from miniSD to phone.
  - **Copy to miniSD/Copy to Phone:** Allows you to copy the video from phone to miniSD, or from miniSD to phone.
  - **Rename:** Allows you to rename the video.
  - **Delete All:** Allows you to delete all the videos.
  - **Details:** Shows details of the video.

## Music

Music stores ringtones, MP3 music, and music you composed. The music file formats supported by the phone are .mp3, .mid, .mmf, .amr and .aac.

1. Scroll to the desired music file.
2. Press  to start playing the music.
3. Press the volume key to adjust volume of the music.
4. When playback stops, press  (**Option**) to **perform the following**:

 The following options marked with an asterisk (\*) are not applicable to DRM (Digital Rights Managements) objects.

- **Set as**: Allows you to set this music file for incoming calls or as a ring ID for a specified contact or a new entry.
- **Details**: Shows details of the music file.
- **Delete\***: Allows you to delete the music file.

## Others

Files that are not supported by your mobile phone are stored here.



## Tools

### Alarm

To set an alarm, follow the steps below:

1. Select an alarm.
2. Scroll to right to turn the status on.
3. Scroll to an option and change the setting as needed.

#### Time

Allows you enter the time for the alarm to sound.

#### Frequency



Allows you to select the days you want the alarm to sound.

#### Alarm Duration

Allows you to set the length of the alarm.

#### Alarm Tone

Allows you to set the ringtone of the alarm.

4. To save all your current alarm settings, press  (**Save**).
5. When setting is saved,  will appear in the display's status bar.

## Clock Options

### World Clocks

Allows you to view six different world clocks. To select different cities, press  (**Edit**).



### Hour Minder

If set to **On**, the phone will emit a beep every hour.

## Calendar









Calendar allows you keep track of upcoming events. You may set the alarm to ring when it comes to the date.

### Creating a new memo

1. When you open the Calendar, the phone will show the calendar for the current date. Scroll to the date you want to write a memo on. You can also press  (**Option**) and select the **Go to Date**.
2. When the desired date is highlighted, press  (**Option**) and select **Add** to open the memo editor.
3. Edit the data fields in the memo editor as needed. Press  (**Save**) to save the memo.



## Calculator

Allows you to use the phone as a calculator.

1. Enter numbers using alphanumeric keys.
2. Press  to perform + (add); Press  to perform - (subtract); Press  to perform / (divide); Press  to perform x (multiply); Press  to get the **result** (equal).
3. Press  to delete numbers and symbols entered. Press  to enter a decimal point. Press  (**Back**) to leave the calculator screen.





## Currency Converter

Currency converter allows you to convert currencies and set the exchange rate.

1. To set the currencies for conversion, press  (**Option**) and select either **Currency 1** (to set the currency at the top of the screen) or **Currency 2** (to set the currency at the bottom of the screen).
2. To set the exchange rate, press  (**Option**) and select **Rate Setting**.
3. Enter the amount of currency and press , the result will appear in the other currency field.



## Stopwatch

Stopwatch allows you to measure times for sports game.

1. Press  to start the stop watch.
2. While the stopwatch is running, you can press  (**Split**) to save each elapsed time.
3. Press  to halt the stopwatch.
4. Scroll to view the list of elapsed times.
5. To reset the stopwatch, press  (**Reset**).

## Countdown Timer

Countdown timer allows you to specify length of time to count down.

1. Enter the length of time you want to count down.
2. Press  and the timer starts counting down to zero.
3. Press  to halt the stopwatch.
4. To reset the stopwatch, press  (**Reset**).

## Connections

### USB

For details, see page 50, "PC Synchronization and Data Transfer".

### Bluetooth

See page 48, "Using the Bluetooth" for details.

## IrDA

IrDA allows you to transmit data through the infrared port.

1. Have the infrared port on your phone aim at the other device's infrared port, then you can start transmitting files through the infrared transmission when the other infrared device has been successfully found.
2. When you have entered the infrared connection, the display will show that it's now connecting.



## Services

Your phone features a WAP browser, allowing you to use the phone for mobile Internet connectivity. You can browse the online services offered by the network operator or ISP, such as information on financial news, sports, travel, and entertainment. To use the phone to get online, necessary UMTS or GPRS configuration, and WAP settings must be made.

 To activate the mobile Internet connectivity, consult your network operator. In general, the network operator will automatically transmit the needed settings to your phone. If not, you will need to manually configure necessary settings. For further details, contact your network operator.

## WAP Browser

Starts up the browser and connects to the homepage.



## WAP Messages

Takes you to the WAP messages Inbox.

## WAP Settings

Allows you to configure settings for different network operators' WAP servers, and then select the desired server to get online.

1. Scroll to the desired server and press  (**Option**) and select **Edit** to manually configure the server's settings as follows:

- **Homepage**  
Sets the homepage that the browser will link to when it is started up.
- **Gateway Address**  
Enter the IP address used for accessing the mobile Internet.
- **Port(0~65535)**  
Enter the connection port specified by the network operator.



For detailed information on how to properly configure GPRS and CSD settings, contact your network operator.

2. Press  to save the settings.

3. Scroll to **Select Gateway** to select your preferred server.

## STK

Shown only if it is provided by your SIM card. For further details, please contact your network operator.



# Settings

## Date & Time

Allows you to set the time and date, as well as the format that will be displayed on the screen.

### Date

Allows you to set today's date.

### Time

Allows you to set the current time.

### Format

Allows you set the format in which the date and the time will be displayed.

### Time Zone

Allows you to select a time zone where you are at.

## Profiles

A profile is a group of settings that determine whether the phone will alert you to incoming calls through a ring tone or a vibrating alert, and how ring tones in general are used on the phone. These settings allow the phone's operations to best suit the environment you are in.

1. Scroll to the desired profile and then press  to activate this profile.

You can choose from among the following profiles:

### Normal

This is the default profile.

## Meeting

The options in this profile have been preset to suit a meeting environment.

## Silent

The options in this profile have been preset to suit an environment where silence is required.

## Outdoors

The options in this profile have been preset to suit an outdoor activity.

## Headset

This option will automatically be selected when a headset is connected to your phone.

## Flight

When you are on a flight, select this option and your phone will be turned off. The alarm and the calendar reminder, if were set to on, will not sound in this mode.

2. To customize settings, scroll to a profile, and then press  (**Edit**).

 You can not modify settings in Silent and Flight mode.

## Vibrate

Decides whether the phone will vibrate when there is an incoming call.

## Call Ring

Allows you to set the ringtone that will sound when there is an incoming call.

### **Message Tone**

Allows you to set the ringtone that will sound when there is a new message.

### **Calendar Tone**

Allows you to set the ringtone that will sound when your calendar event approaches.

### **Keypad Tone**

Decides whether keypad will sound when keys are pressed.

### **Ring Volume**

Allows you to adjust the ring volume.

### **Restore**

Allows you to reset the profile to its default configuration.



Requires the entry of the phone code (The default phone code is 1234).

## **Display**

### **Wallpaper**

Designates the wallpaper used for the idle screen of main display and sub display.

### **Personal Banner**

Enter the text you want to be displayed on the idle screen.

### **Contrast**

Allows you to adjust contrast of the display. Scroll up or down to adjust it.

## Backlight

### Brightness

Allows you to adjust brightness of the display to be appeared lighter or darker. Scroll up or down to adjust it.

### Duration

Allows you to set the duration the backlight stays on.

## Call Settings

### Answer Mode

#### Send Key:

Allows incoming calls to be answered only by pressing .

#### Any Key:

Allows any key except  to be used to answer an incoming call.

#### Flip Answer

Allows incoming calls to be answered by opening the flip.

### Connect Alert

This feature allows the phone to ring, vibrate, or flash the backlighting when the recipient of a call has answered.

### Minute Minder

If set the status On, the phone will emit a beep every minute during a call.

## Show Number

Decides whether your phone number will be displayed on the recipient's phone when you make a call. Select **Preset** to be determined by the default set by the network operator.

## Call Divert

This feature allows you to divert calls to a designated phone number or voicemail box.



Requires the support of the network operator.

### Forward All

Diverts all incoming calls.

### When Busy

Diverts incoming calls when you are in the middle of another call.

### No Reply

Diverts incoming calls when you do not answer.

### Not Reachable

Diverts incoming calls when your phone is turned off or outside network coverage.

### Cancel All

Cancels all call divert options.

## Call Barring

You can request that your network operator block the dialing or receiving of certain calls. To activate or cancel any of the options below, you must enter the network password provided by the network operator.

 Requires the support of the network operator.

### **All Outgoing**

Blocks dialing of any calls from the phone.

### **Intl. Out**

If this option is activated, no international calls can be made with your phone.

### **Intl. Except Home**

If this option is activated, your phone can only be used to dial local calls and calls to your home country from abroad. Other international calls will be barred.

### **All Incoming**

Rejects all incoming calls.

### **Incoming When Roaming**

If you are in another country (using roaming), activating this option will cause the phone to reject all incoming calls.

### **Cancel All**

Cancels all call barring settings. You must enter the network password in order to cancel these settings.

### **Change Password**

You can change the network password, which can be obtained from the network operator.

## Call Waiting

If there is an incoming call when you are in the middle of another call, the screen will display the number of the incoming call and call waiting message to alert you. You can activate, cancel, or view the status of this feature from this menu.

 Requires the support of the network operator.

## Auto Redial

If there is no answer at a number you have dialed, the phone will automatically redial.



## Fixed Dialing Number

After this feature is activated, the phone will only be able to dial numbers on the Fixed Dial Number list. If a number is not on the list, calls cannot be made to this number.

 To activate or cancel this feature, you must enter the PIN2 code.

 If the PIN2 code is entered incorrectly three consecutive times, the PIN2 code will be locked down. You will need the PUK2 code to unlock the PIN2 code. Contact your network operator to obtain the PUK2 code.

To create a Fixed Dialing Number list,

1. Press  (**View**), then press  (**Option**) and select **Add**.
2. Enter the PIN2 code, and then add a new number to your Fixed Dial Number list.



## Network

Generally speaking, the network that your phone uses is configured automatically. When turned on, the phone will automatically connect to the network provided by your network operator, or will automatically connect to the roaming network when you are outside the coverage of your regular network. When outside the coverage of your regular network, you can manually select the local network system.

 Requires the support of the network operator.

### Search Mode

Allows you to set the network searching automatic or manual.

#### **Automatic:**

If this option is selected, when outside the coverage of your regular network, the phone will automatically search for the available network.

#### **Manual:**

If this option is selected, when outside the coverage of your regular network, the phone will list all the networks of telecom vendors and allow you to choose.

### 3G/GSM Networks

Allows you to set the type of networks that the phone will search for when it is turned on.

#### **3G and GSM:**

If this option is selected, the phone will search for available UMTS and GSM networks. Select this option if you use an USIM card on your phone.

### **GSM Only:**

If this option is selected, the phone will search only for GSM networks. Select this option if you use a SIM card for GSM network on your phone.

## **Security**

You can use various codes and locks to prevent unauthorized use of the phone.

### **PIN Code**

The PIN (Personal Identification Number) is the password provided by your network operator. You need this password in order to use the SIM card.



If you enter the PIN incorrectly three times in a row, the SIM card will be locked. You must now enter the PUK (Personal Unblocking Key) for that SIM card in order to unlock it. Please contact your network operator to obtain a PUK.

### **PIN1 Code**

Used to activate, deactivate or change the PIN1 Code. To change the PIN1 Code, select **Set Status** and set to **On**. Enter PIN1.

### **PIN2 Code**

Used to change the PIN2 code. The procedure is the same as for the PIN1 Code.

## Phone Code

Once the phone lock is activated, you will be required to enter the phone code when the phone is turned on. You must enter the correct code to unlock it (the default phone code is 1234). When the phone is locked, you will only be able to make emergency calls.

## Power Saving

Activating this mode will turn off the keypad backlighting and the brightness of the display backlighting will be reduced to conserve battery power.

## Language

Allows you to select the language that the phone will use.

## Power On/Off Sound

Allows you to determine whether your phone will emit a sound when the phone is turned on or off.

## Memory

Shows you the amount of used and remaining memory in your phone and in your miniSD card.

## Restore

Restores all the settings to their factory default.

 Requires the entry of the phone code (The default phone code is 1234).

## **5** Care and Maintenance

Take note of the points noted below to ensure that you are using the phone properly and to extend the lifespan of the phone.

- Store the phone and its accessories out of the reach of children.
- Keep the phone and accessories dry, and use the phone in environments where the temperature is between  $-10^{\circ}\text{C}$  and  $45^{\circ}\text{C}$ . High or low temperatures outside this range may damage the phone.
- If possible, do not use or store the phone in excessively dusty or dirty environments.
- Do not remove the warranty seal on the phone yourself, nor allow an unauthorized dealer to do so.
- Do not use strong detergents or organic solvents to wipe or clean the phone.
- If your phone or its accessories are not operating normally, contact an authorized dealer immediately.
- Use only genuine Benq accessories such as batteries, battery charger and hands-free kit to ensure the phone's normal operation and preserve battery life, as well as protect the safety of your person and belongings. Use of non-Benq accessories will not allow your phone to achieve optimal performance, and may cause the phone to malfunction. Any malfunctions or damage caused by the use of third-party accessories are not covered by the terms of the product warranty, and will void the product warranty.
- Avoid allowing objects that may discharge electricity to contact the charging socket on the bottom of the phone or the metal contacts on the battery, as this may cause short circuits and put you in danger.

## **Battery quality statement**

The capacity of your mobile phone battery will reduce each time it is charged/emptied. Storage at too high or low temperatures will also result in a gradual capacity loss. As a result the operating time of your mobile phone may be considerably reduced, even after a full recharge of the battery.

Regardless of this, the battery has been designed and manufactured so that it can be recharged and used for six months after the purchase of your mobile phone. After six months, if the battery is clearly suffering from loss of performance, we recommend that you replace it. Please buy only Benq original batteries.

## **Display quality declaration**

For technological reasons, a few small dots with different colours may appear in the display in exceptional cases.

Just remember that the appearance of brighter or darker dots generally does not mean that a fault has occurred.

# Troubleshooting

If you encounter problems while using the phone, or if it performs erratically, you can consult the information in the chart below. If your particular problem cannot be resolved using the information in the chart, contact the dealer where you purchased the phone.

Problem	Possible cause	Solution
Poor reception	<ul style="list-style-type: none"><li>• The network signal is too weak at your current location—for example, in a basement or near a tall building—because wireless transmissions can not effectively reach it.</li></ul>	Move to a location where the network signal can be properly received.
	<ul style="list-style-type: none"><li>• The network is busy at the current time (for example, during peak times, there may be too much network traffic to handle additional calls).</li></ul>	Avoid using the phone at such times, or try again after waiting a short time.
	<ul style="list-style-type: none"><li>• You are too far away from a base station for your network operator.</li></ul>	You can request a service area map from your network operator.
Echo or noise	<ul style="list-style-type: none"><li>• Poor network trunk quality on the part of your network operator.</li></ul>	Hang up the phone and dial again. You may be switched to a better-quality network trunk or phone line.
	<ul style="list-style-type: none"><li>• Poor local telephone line quality.</li></ul>	

<b>Problem</b>	<b>Possible cause</b>	<b>Solution</b>
Shortened standby time	<ul style="list-style-type: none"> <li>• The standby time is related to your network operator's system configuration. The same phone used with different network operators' systems will not provide exactly the same length of standby time.</li> </ul>	If you are located in an area where signaling is weak, temporarily shut off the phone.
	<ul style="list-style-type: none"> <li>• The battery is depleted. In high-temperature environments, battery life will be shortened.</li> </ul>	Use a new battery.
	<ul style="list-style-type: none"> <li>• If you are not able to connect to the network, the phone will continue to send out signals as it attempts to locate a base station. Doing so consumes battery power and will consequently shorten standby time.</li> </ul>	Change your location to one where the network is accessible, or temporarily turn off your phone.
You cannot switch your phone on.	<ul style="list-style-type: none"> <li>• Battery power has been depleted.</li> </ul>	Recharge the phone's battery.
SIM card error	<ul style="list-style-type: none"> <li>• SIM card malfunction or damage.</li> </ul>	Take the SIM card to your network operator for testing.
	<ul style="list-style-type: none"> <li>• SIM card inserted improperly.</li> </ul>	Insert the SIM card properly.
	<ul style="list-style-type: none"> <li>• Debris on the SIM card contacts.</li> </ul>	Use a soft, dry cloth to clean the SIM card contacts.

Problem	Possible cause	Solution
Unable to connect to the network.	• SIM card invalid.	Contact your network operator.
	• You are not within the network's service area.	Check the service area with your network operator.
	• Poor signal.	Move to an open space, or if you are inside a building, move closer to a window.
You cannot answer incoming calls.	• You have activated <b>Reject List</b> in the <b>Caller Groups</b> option.	Go to <b>Phone Book &gt; Caller Groups &gt; Reject List</b> in order to remove contacts from the list.
	• You have activated the <b>Call Barring</b> feature.	Go to <b>Settings &gt; Call Settings &gt; Call Barring</b> , and then select <b>Cancel All</b> .
You cannot make outgoing calls.	• You have activated the <b>Call Barring</b> feature.	Go to <b>Settings &gt; Call Settings &gt; Call Barring</b> , and then select <b>Cancel All</b> .
	• You have activated the <b>Fixed Dialing Number</b> feature.	Go to <b>Settings &gt; Call Settings &gt; Fixed Dialing Number</b> to turn this feature off.
PIN Code is blocked.	• You have entered an incorrect PIN code three consecutive times.	Contact your network operator. If the network operator provides the SIM card's PUK code, use the PUK code to unlock the SIM card.
Battery will not charge.	• The battery or battery charger is damaged.	Contact the dealer.
	• The phone's temperature is below 0°C or higher than 45°C.	Adjust the battery charging environment to avoid extremes of temperature.
	• Poor contact between the battery and charger.	Check all connectors to make sure all connections have been properly made.



Problem	Possible cause	Solution
Unable to enter information into the Phone Book.	<ul style="list-style-type: none"><li data-bbox="288 148 591 198">• The Phone Book's memory is already full.</li></ul>	Delete unnecessary data from the Phone Book.
Unable to select certain features.	<ul style="list-style-type: none"><li data-bbox="288 312 591 436">• Your network operator does not support these features, or you have not applied for services that provide these features.</li></ul>	Contact your network operator.

## Customer Care

We offer fast, individual advice! You have several options:

Our online support on the Internet:

**[www.siemens.com/mobilephonescustomercare](http://www.siemens.com/mobilephonescustomercare)**



We can be reached any time, any place. You are given 24 hour support on all aspects of our products. Here you will find an interactive fault-finding system, a compilation of the most frequently asked questions and answers, plus user guides and current software updates to download.

You will also find the most frequently asked questions and answers in the section entitled "Troubleshooting" in this user guide on page 77.

You can also get personal advice about our range of products on our Premium Hotline:

**United Kingdom..... 0906 9597500**

(0.75 £ per minute)

Qualified employees are waiting to offer you expert information about our products and installation.

In some countries repair and replace services are impossible where the products are not sold through our authorised dealers.

If repair work is necessary, please contact one of our service centres:

Abu Dhabi ..... 0 26 42 38 00

Argentina ..... 0 81 02 22 66 24

Australia..... 13 00 66 53 66

Austria..... 05 17 07 50 04

Bahrain ..... 40 42 34

Bangladesh..... 0 17 52 74 47

Belgium.....	0 78 15 22 21
Bolivia .....	0 21 21 41 14
Bosnia Herzegovina .....	0 33 27 66 49
Brunei .....	02 43 08 01
Bulgaria.....	02 73 94 88
Cambodia .....	12 80 05 00
Canada .....	1 88 87 77 02 11
Chile.....	8 00 53 06 62
China.....	40 08 88 56 56
Colombia .....	01 80 07 00 66 24
Croatia .....	0 16 10 53 81
Czech Republic .....	2 33 03 27 27
Denmark.....	35 25 86 00
Dubai .....	0 43 96 64 33
Ecuador.....	18 00 10 10 00
Egypt.....	0 23 33 41 11
Estonia .....	6 30 47 97
Finland.....	09 22 94 37 00
France.....	01 56 38 42 00
Germany .....	0 18 05 33 32 26
Greece .....	80 11 11 11 16
Hong Kong .....	28 61 11 18
Hungary.....	06 14 71 24 44
Iceland.....	5 11 30 00
India.....	22 24 98 70 00 Extn: 70 40
Indonesia .....	0 21 46 82 60 81
Ireland.....	18 50 77 72 77
Italy .....	02 24 36 44 00

Ivory Coast.....	05 02 02 59
Jordan.....	0 64 39 86 42
Kenya.....	2 72 37 17
Kuwait.....	2 45 41 78
Latvia.....	7 50 11 18
Lebanon.....	01 44 30 43
Libya.....	02 13 50 28 82
Lithuania.....	8 70 07 07 00
Luxembourg.....	43 84 33 99
Macedonia.....	0 23 13 14 84
Malaysia.....	+ 6 03 77 12 43 04
Malta.....	+ 35 32 14 94 06 32
Mauritius.....	2 11 62 13
Mexico.....	01 80 07 11 00 03
Morocco.....	22 66 92 09
Netherlands.....	0 90 03 33 31 00
New Zealand.....	08 00 27 43 63
Nigeria.....	0 14 50 05 00
Norway.....	22 70 84 00
Oman.....	79 10 12
Pakistan.....	02 15 66 22 00
Paraguay.....	8 00 10 20 04
Peru.....	0 80 05 24 00
Philippines.....	0 27 57 11 18
Poland.....	08 01 30 00 30
Portugal.....	8 08 20 15 21
Qatar.....	04 32 20 10
Romania.....	02 12 09 99 66

Russia .....	8 80 02 00 10 10
Saudi Arabia .....	0 22 26 00 43
Serbia .....	01 13 07 00 80
Singapore .....	62 27 11 18
Slovak Republic .....	02 59 68 22 66
Slovenia.....	0 14 74 63 36
South Africa.....	08 60 10 11 57
Spain .....	9 02 11 50 61
Sweden .....	0 87 50 99 11
Switzerland .....	08 48 21 20 00
Taiwan.....	02 23 96 10 06
Thailand.....	0 27 22 11 18
Tunisia.....	71 86 19 02
Turkey .....	0 21 64 59 98 98
Ukraine .....	8 80 05 01 00 00
United Arab Emirates .....	0 43 66 03 86
United Kingdom.....	0 87 05 33 44 11
Uruguay .....	00 04 05 46 62
USA .....	1 88 87 77 02 11
Venezuela .....	0 80 01 00 56 66
Vietnam .....	84 89 20 24 64
Zimbabwe .....	04 36 94 24



## European Union (RTTE) and international (ICNIRP)

INFORMATION ON RF EXPOSURE / SPECIFIC ABSORPTION RATE (SAR)

THIS MODEL MEETS INTERNATIONAL GUIDELINES FOR EXPOSURE TO RADIO WAVES

Your mobile device is a radio transmitter and receiver. It is designed not to exceed the limits for exposure to radio waves recommended by international guidelines. These guidelines were developed by the independent scientific organization ICNIRP and include safety margins designed to assure the protection of all persons, regardless of age and health.

The guidelines use a unit of measurement known as the Specific Absorption Rate, or SAR. The SAR limit for mobile devices is 2 W/kg and was adopted into the European Standard EN 50360 and into other national standards. The CE mark demonstrates that the EU requirements are met.

The highest SAR value for this device when tested at the ear was **0.65 W/kg<sup>1</sup>**. As mobile devices offer a range of functions, they can be used in positions other than the head, such as on the body. In this case, at data transfer (GPRS) a separation distance of **1.5 cm** is required.

- 
1. The tests are carried out in accordance with international guidelines for testing.

As SAR is measured utilizing the device's highest transmitting power, the actual SAR of this device while operating is typically below that indicated above. This is due to automatic changes to the power level of the device to ensure it only uses the minimum level required to reach the network.

The World Health Organization has stated that present scientific information does not indicate the need for any special precautions for the use of mobile devices. They note that if you nevertheless want to reduce your exposure then you can do so by limiting the length of calls or using a 'hands-free' device to keep the mobile phone away from the head and body.

Additional Information can be found on the websites of the World Health Organization ([www.who.int/emf](http://www.who.int/emf)) or BenQ Mobile ([www.benqmobile.com](http://www.benqmobile.com)).



## **Guarantee certificate (UK)**

Without prejudice to any claim the user (customer) may have in relation to the dealer or retailer, the customer shall be granted a manufacturer's Guarantee under the conditions set out below:

- In the case of new devices and their components exhibiting defects resulting from manufacturing and/or material faults within 24 months of purchase, Siemens shall, at its own option and free of charge, either replace the device with another device reflecting the current state of the art, or repair the said device. In respect of parts subject to wear and tear (including but not limited to, batteries, keypads, casings, small parts on casings, protective coverings where included in the scope of delivery), this warranty shall be valid for six months from the date of purchase.
- This Guarantee shall be invalid if the device defect is attributable to improper treatment and/or failure to comply with information contained in the user manuals.
- This Guarantee shall not apply to or extend to services performed by the authorised dealer or the customer themselves (e.g. installation, configuration, software downloads). User manuals and any software supplied on a separate data medium shall be excluded from the Guarantee.
- The purchase receipt, together with the date of purchase, shall be required as evidence for invoking the Guarantee. Claims under the Guarantee must be submitted within two months of the Guarantee default becoming evident.
- Ownership of devices or components replaced by and returned to Siemens shall vest in Siemens.



- This Guarantee shall apply to new devices purchased in the European Union. For Products sold in the United Kingdom the Guarantee is issued by Siemens plc, Siemens House, Oldbury, Bracknell, Berkshire, RG12 8FZ.
- Any other claims resulting out of or in connection with the device shall be excluded from this Guarantee. Nothing in this Guarantee shall attempt to limit or exclude a Customers Statutory Rights, nor the manufacturer's liability for death or personal injury resulting from its negligence.
- The duration of the Guarantee shall not be extended by services rendered under the terms of the Guarantee.
- Insofar as no Guarantee default exists, Siemens reserves the right to charge the customer for replacement or repair.
- The above provisions does not imply a change in the burden of proof to the detriment of the customer.

To invoke this Guarantee, please contact our online support on the Internet **[www.siemens.com/mobilephonescustomercare](http://www.siemens.com/mobilephonescustomercare)** or the Siemens telephone service. The relevant number is to be found in the accompanying user guide.

## 10 Guarantee certificate (IRL)

Without prejudice to any claim the user (customer) may have in relation to the dealer or retailer, the customer shall be granted a manufacturer's Guarantee under the conditions set out below:

- In the case of new devices and their components exhibiting defects resulting from manufacturing and/or material faults within 24 months of purchase, Siemens shall, at its own option and free of charge, either replace the device with another device reflecting the current state of the art, or repair the said device. In respect of parts subject to wear and tear (including but not limited to, batteries, keypads, casings, small parts on casings, protective coverings where included in the scope of delivery), this warranty shall be valid for six months from the date of purchase.
- This Guarantee shall be invalid if the device defect is attributable to improper care or use and/or failure to comply with information contained in the user manuals.
- In particular claims under the Guarantee cannot be made if:
  - The device is opened (this is classed as third party intervention)
  - Repairs or other work done by persons not authorised by Siemens.
  - Components on the printed circuit board are manipulated
  - The software is manipulated
  - Defects or damage caused by dropping, breaking, lightning or ingress of moisture. This also applies if defects or damage was caused by mechanical, chemical, radio interference or thermal factors (e.g.: microwave, sauna etc.)
  - Devices fitted with accessories not authorised by Siemens

- This Guarantee shall not apply to or extend to services performed by the authorised dealer or the customer themselves (e.g. installation, configuration, software downloads). User manuals and any software supplied on a separate data medium shall be excluded from the Guarantee.
- The purchase receipt, together with the date of purchase, shall be required as evidence for invoking the Guarantee. Claims under the Guarantee must be submitted within two months of the Guarantee default becoming evident.
- Ownership of devices or components replaced by and returned to Siemens shall vest in Siemens.
- This Guarantee shall apply to new devices purchased in the European Union. For Products sold in the Republic of Ireland the Guarantee is issued by Siemens Ireland Limited, Ballymoss Road, Sandyford Industrial Estate, Dublin 18 - The Republic of Ireland.
- Any other claims resulting out of or in connection with the device shall be excluded from this Guarantee. Nothing in this Guarantee shall attempt to limit or exclude a Customers Statutory Rights, nor the manufacturer's liability for death or personal injury resulting from its negligence.
- The duration of the Guarantee shall not be extended by services rendered under the terms of the Guarantee.
- Insofar as no Guarantee default exists, Siemens reserves the right to charge the customer for replacement or repair.
- The above provisions does not imply a change in the burden of proof to the detriment of the customer.

To invoke this Guarantee, please contact our online support on the Internet **[www.siemens.com/mobilephonescustomercare](http://www.siemens.com/mobilephonescustomercare)** or the Siemens telephone service. The relevant number is to be found in the accompanying user guide.

# 11 End User License Agreement (EULA)

This License Agreement ("Agreement") is between You and BenQ Mobile GmbH & Co. OHG, Germany ("BenQ"). The Agreement authorizes You to use the Licensed Software, specified in Clause 1 below, which may be included in your phone, stored on a CD-ROM, sent to You by electronic mail or over the air, downloaded from BenQ Web pages or servers or from other sources under the terms and conditions set forth below.

Read this Agreement carefully before using your phone. By using your phone or installing, copying, and/or using the Licensed Software, You acknowledge that You have read and understood the Agreement and agree to be bound by all of the terms and conditions stated below. You further agree that if BenQ or any licensor of BenQ ("Licensor") is required to engage in any proceeding, legal or otherwise, to enforce their rights under this Agreement, BenQ and/or its Licensor shall be entitled to recover from You, in addition to any other sums due, reasonable attorney's fees, costs and disbursements. If You do not agree to all of the terms and conditions of this Agreement, do not install or use the Licensed Software. This Agreement governs any Updates, releases, revisions, or enhancements to the Licensed Software.

1. LICENSED SOFTWARE. As used in this Agreement, the term "Licensed Software" means collectively: all the software in Your phone, all of the contents of the disk(s), CD-ROM(s), electronic mail and its file attachments, or other media with which this Agreement is provided and includes any related BenQ or third party software and upgrades, modified versions, updates, additions and copies of the Licensed Software, if any, distributed over the air, downloaded from BenQ Web pages or servers or from other sources.

2. **COPYRIGHT.** The Licensed Software and all related rights, without limitation including proprietary rights therein, are owned by BenQ, its Licensors or affiliates and are protected by international treaty provisions and all applicable national laws. This Agreement does not convey to You nor allow You to acquire any title or ownership interest in the Licensed Software or rights therein. The structure, organization, data and code of the Licensed Software are the valuable trade secrets and confidential information of BenQ, its Licensors or affiliates. You must reproduce and include the copyright notices with any permitted copies You make of the Licensed Software.

3. **LICENSE AND USE.** BenQ grants to You a non-exclusive, non-transferable end user right to install the Licensed Software or use the Licensed Software installed on the phone. The Licensed Software is licensed with the phone as a single integrated product and may be used with the phone only as set forth in these licensing terms.

4. **LIMITATIONS ON LICENSE.** You may not copy, distribute, or make derivative works of the Licensed Software except as follows:

a) You may make one copy of the Licensed Software, excluding the documentation, as an archival backup copy of the original. Any other copies You make of the Licensed Software are in violation of this Agreement.

b) You may not use, modify, or transfer the right to use the Licensed Software other than together with the accompanying hardware or copy the Licensed Software except as expressly provided in this Agreement.

c) You may not sublicense, rent or lease the Licensed Software.

d) You may not reverse engineer, decompile, modify, or disassemble those Licensed Software programs except and only to the extent that such activity is expressly permitted by applicable law notwithstanding this limitation.

Parts of the Licensed Software may be supplied by third parties and may be subject to separate license terms. Such terms are set out within the documentation.

5. MISUSE OF THE LICENSED SOFTWARE OR DATA GENERATED BY THE LICENSED SOFTWARE IS STRICTLY PROHIBITED BY BENQ, MAY VIOLATE GERMAN, U.S. AND OTHER LAWS AND MAY SUBJECT YOU TO SUBSTANTIAL LIABILITY. You are solely responsible for any misuse of the Licensed Software under this Agreement and for any liability or damage related in any way to your use of the Licensed Software in violation of this Agreement. You are also responsible for using the Licensed Software in accordance with the limitations of this Agreement.

6. TERMINATION. This Agreement is effective from the first date You install, copy or otherwise use the Licensed Software. You may terminate this license at any time by deleting or destroying the Licensed Software, all back up copies and all related materials provided to You by BenQ. Your license rights terminate automatically and immediately without notice if You fail to comply with any provision of this Agreement. The rights and obligations under sections 2, 5, 6, 7, 9, 12 and 13 of this Agreement shall survive the termination of this Agreement.

7. YOU ACKNOWLEDGE THE LICENSED SOFTWARE IS PROVIDED "AS IS" AND NEITHER BENQ NOR ANY OF ITS LICENSORS MAKE ANY REPRESENTATIONS OR WARRANTIES, EXPRESS OR IMPLIED, INCLUDING BUT NOT LIMITED TO THE WARRANTIES OF MERCHANTABILITY OR FITNESS FOR A PARTICULAR PURPOSE OR THAT THE LICENSED SOFTWARE WILL NOT INFRINGE ANY THIRD PARTY PATENTS, COPYRIGHTS, TRADEMARKS OR OTHER RIGHTS. THERE IS NO WARRANTY BY BENQ OR ITS LICENSORS OR BY ANY OTHER PARTY THAT THE FUNCTIONS CONTAINED IN THE LICENSED SOFTWARE WILL MEET YOUR REQUIREMENTS OR THAT THE OPERATION OF THE

LICENSED SOFTWARE WILL BE UNINTERRUPTED OR ERROR-FREE AND BENQ AND ITS LICENSORS HEREBY DISCLAIM ANY AND ALL LIABILITY ON ACCOUNT THEREOF. NO ORAL OR WRITTEN INFORMATION OR ADVICE GIVEN BY A BENQ REPRESENTATIVE SHALL CREATE A WARRANTY OR IN ANY WAY AFFECT THIS DISCLAIMER. YOU ASSUME ALL RESPONSIBILITY TO ACHIEVE YOUR INTENDED RESULTS AND FOR THE INSTALLATION, USE, AND RESULTS OBTAINED FROM IT.

8. NO OTHER OBLIGATIONS. This Agreement creates no obligations on the part of BenQ other than as specifically set forth herein.

9. LIMITATION OF LIABILITY. IN NO EVENT SHALL BENQ, ITS EMPLOYEES, LICENSORS, AFFILIATES OR AGENTS BE LIABLE FOR ANY DIRECT DAMAGES, LOST PROFITS, DATA OR BUSINESS, OR COSTS OF PROCUREMENT OF SUBSTITUTE GOODS OR SERVICES, PROPERTY DAMAGE, INTERRUPTION OF BUSINESS OR FOR ANY SPECIAL, INDIRECT, INCIDENTAL, EXEMPLARY, ECONOMIC, PUNITIVE OR CONSEQUENTIAL DAMAGES, HOWEVER CAUSED, AND WHETHER ARISING UNDER CONTRACT, TORT, NEGLIGENCE, OR OTHER THEORY OF LIABILITY, OR ARISING OUT OF THE USE OF OR INABILITY TO USE THE LICENSED SOFTWARE, EVEN IF BENQ IS ADVISED OF THE POSSIBILITY OF SUCH DAMAGES. THE LIMITATION OF LIABILITY SHALL NOT APPLY IF AND TO THE EXTENT BENQ'S LIABILITY IS MANDATORY UNDER THE APPLICABLE LAW E.G. ACCORDING TO PRODUCT LIABILITY LAW OR IN THE EVENT OF INTENTIONAL MISCONDUCT, PERSONAL INJURY OR DEATH.

10. TECHNICAL SUPPORT. BenQ and its Licensors have no obligation to furnish You with technical support unless separately agreed in writing between You and BenQ or the applicable Licensor.



BenQ and where applicable its Licensors in the Licensed Software shall be free to use any feedback received from You resulting from your access to and use of the Licensed Software for any purpose including (without limitation) the manufacture, marketing and maintenance or support of products and services.

11. **EXPORT CONTROL.** The Licensed Software may include technical data and cryptographic software and is subject to German, European Union and U.S. export controls and may be subject to import or export controls in other countries. You agree to strictly comply with all applicable import and export laws and regulations. Specifically, You agree, to the extent required by U.S. Export Administration Regulations, that You shall not disclose or otherwise export or re-export the Licensed Software or any part thereof delivered under this Agreement to (a) Cuba, Iran, Iraq, Libya, North Korea, Sudan, Syria or any other country (including a national or resident of such country) to which the U.S. has restricted or prohibited the export of goods or services.

12. **APPLICABLE LAW AND FORUM.** The laws of Germany govern this Agreement. No choice of law rules of any jurisdiction will apply. The courts in Munich shall settle any disputes arising out of or relating to this Agreement provided you are a merchant.

13. **MISCELLANEOUS.** This Agreement represents the entire agreement between You and BenQ relating to the Licensed Software and (i) supersedes all prior or contemporaneous oral or written communications, proposals, and representations with respect to its subject matter; and (ii) prevails over any conflicting or additional terms of any acknowledgement or similar communication between the parties during the term of this License. Notwithstanding the foregoing, some products of BenQ may require You to agree to additional terms through an on-line "click-wrap" license, and such terms shall supplement this Agreement. If any provision of this Agreement is held invalid, all other provisions shall remain valid

unless such validity would frustrate the purpose of this Agreement, and this Agreement shall be enforced to the full extent allowable under applicable law. No modification to this Agreement is binding, unless in writing and signed by a duly authorized representative of each party. This Agreement shall be binding on and shall inure to the benefit of the heirs, successors, and assigns of the parties hereto. The failure of either party to enforce any right resulting from the breach of any provision of this Agreement by the other party will not be deemed a waiver of any right related to a subsequent breach of such provision or any other right hereunder. Notwithstanding anything to the contrary in this Agreement, BenQ and/or its licensors may enforce its rights, including but not limited to copyright, trademark or trade names, in accordance with the rules of law in each country.

© BenQ Mobile GmbH & Co. OHG 2005. BenQ Mobile GmbH & Co. OHG is a trademark licensee of Siemens AG.